

A (a)

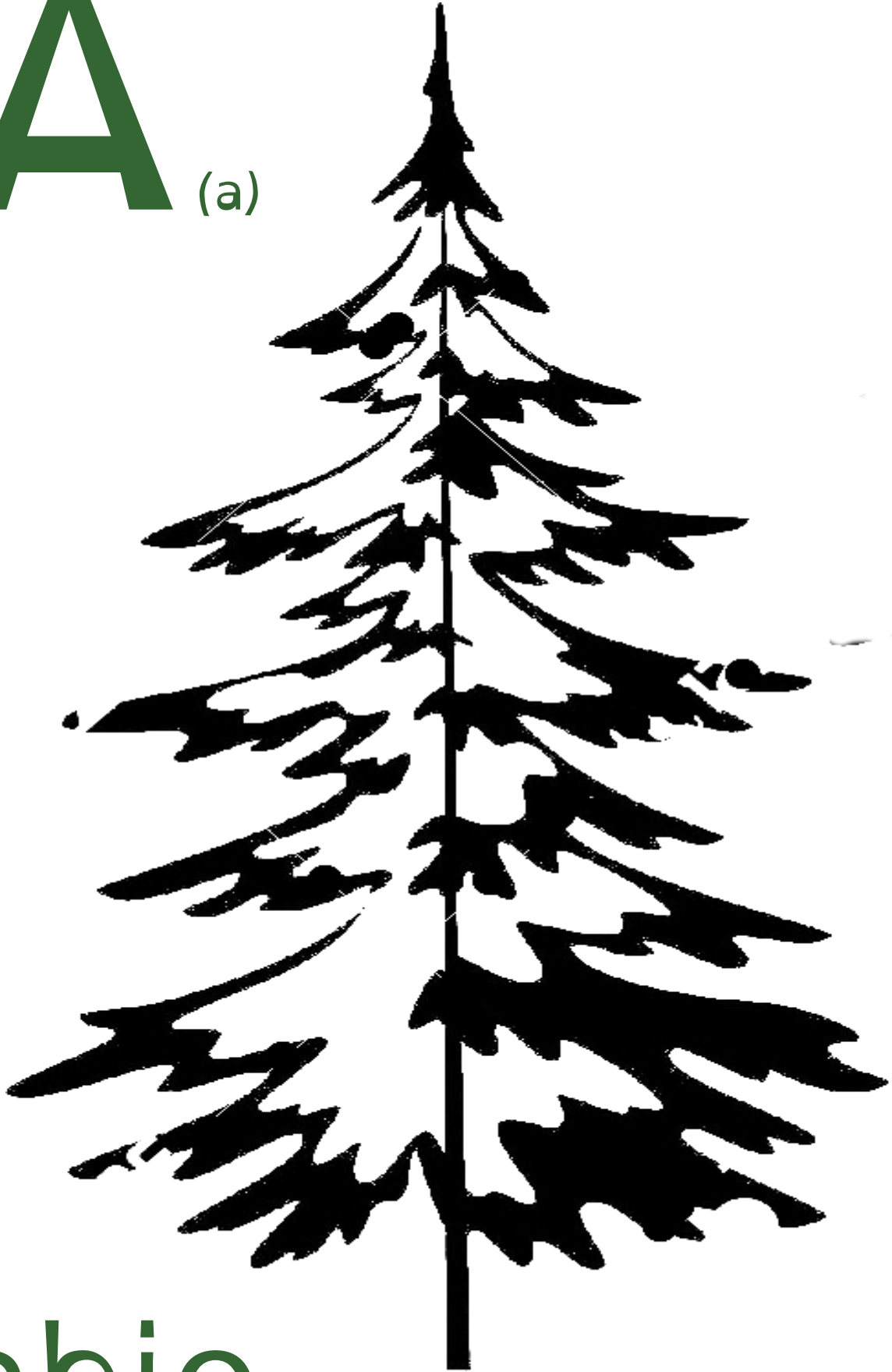

abio

B

(b)

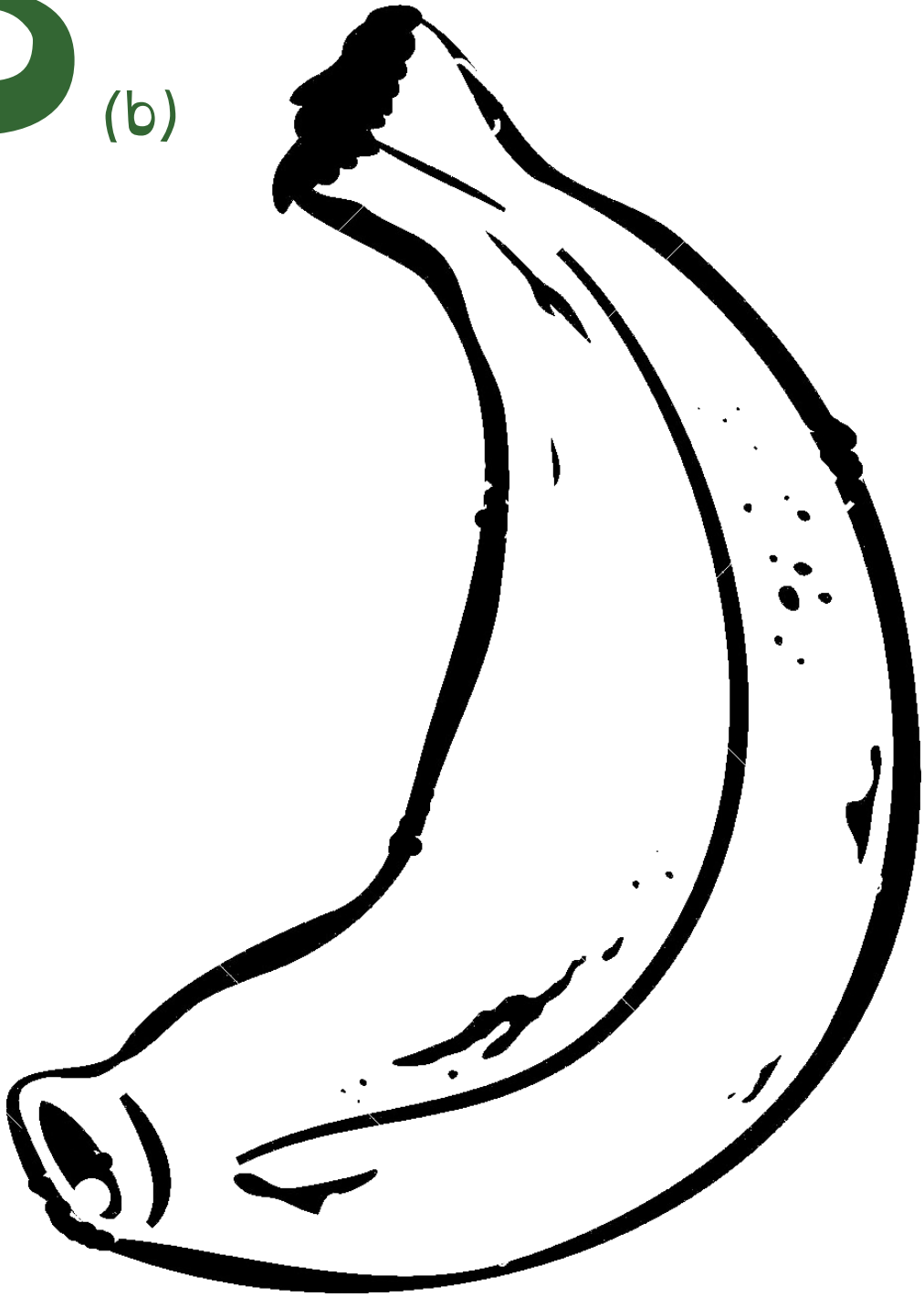

banano

C (ts)

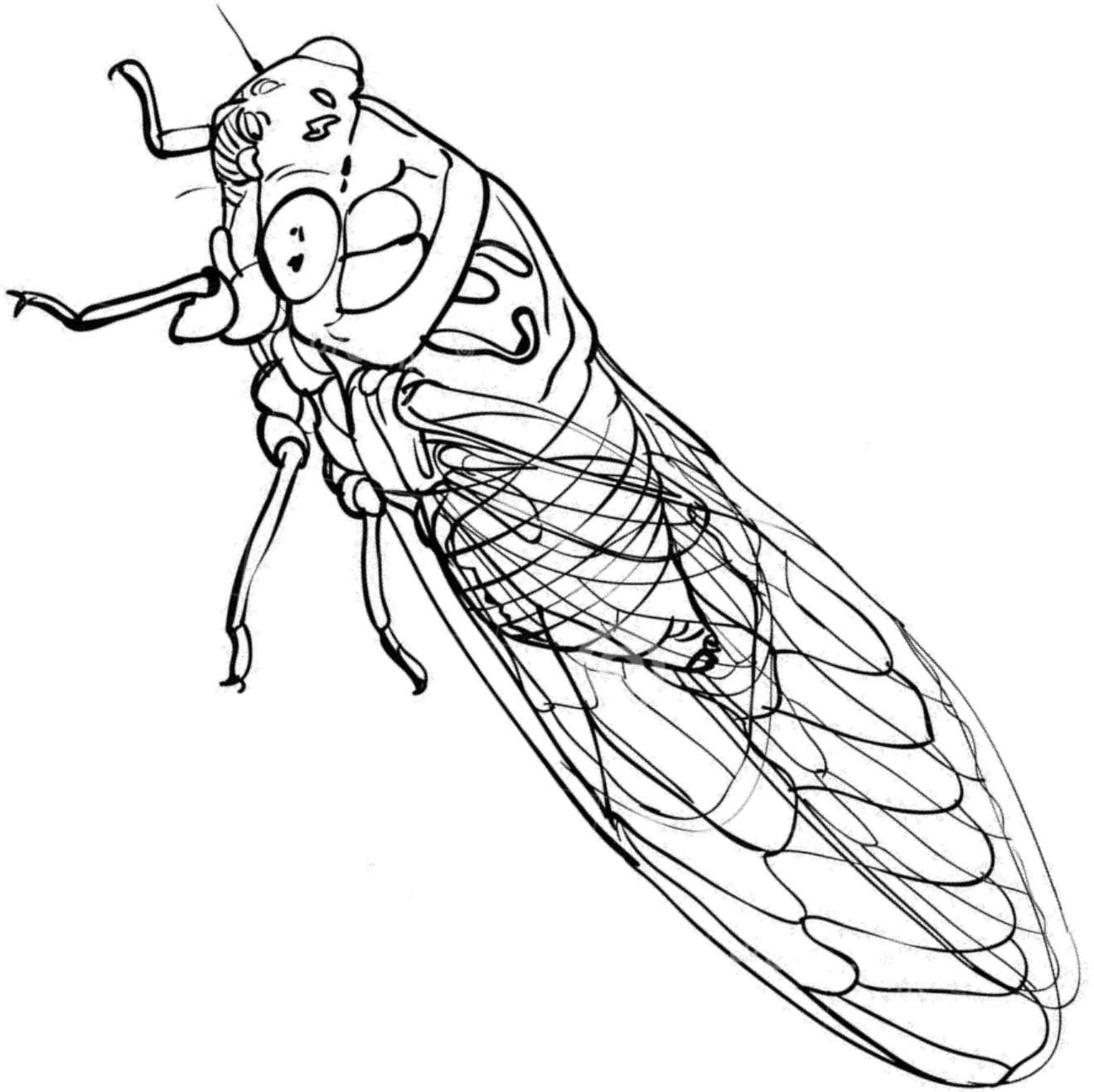

cikado

Ĉ (t ŝ)



ĉapo

D

(d)

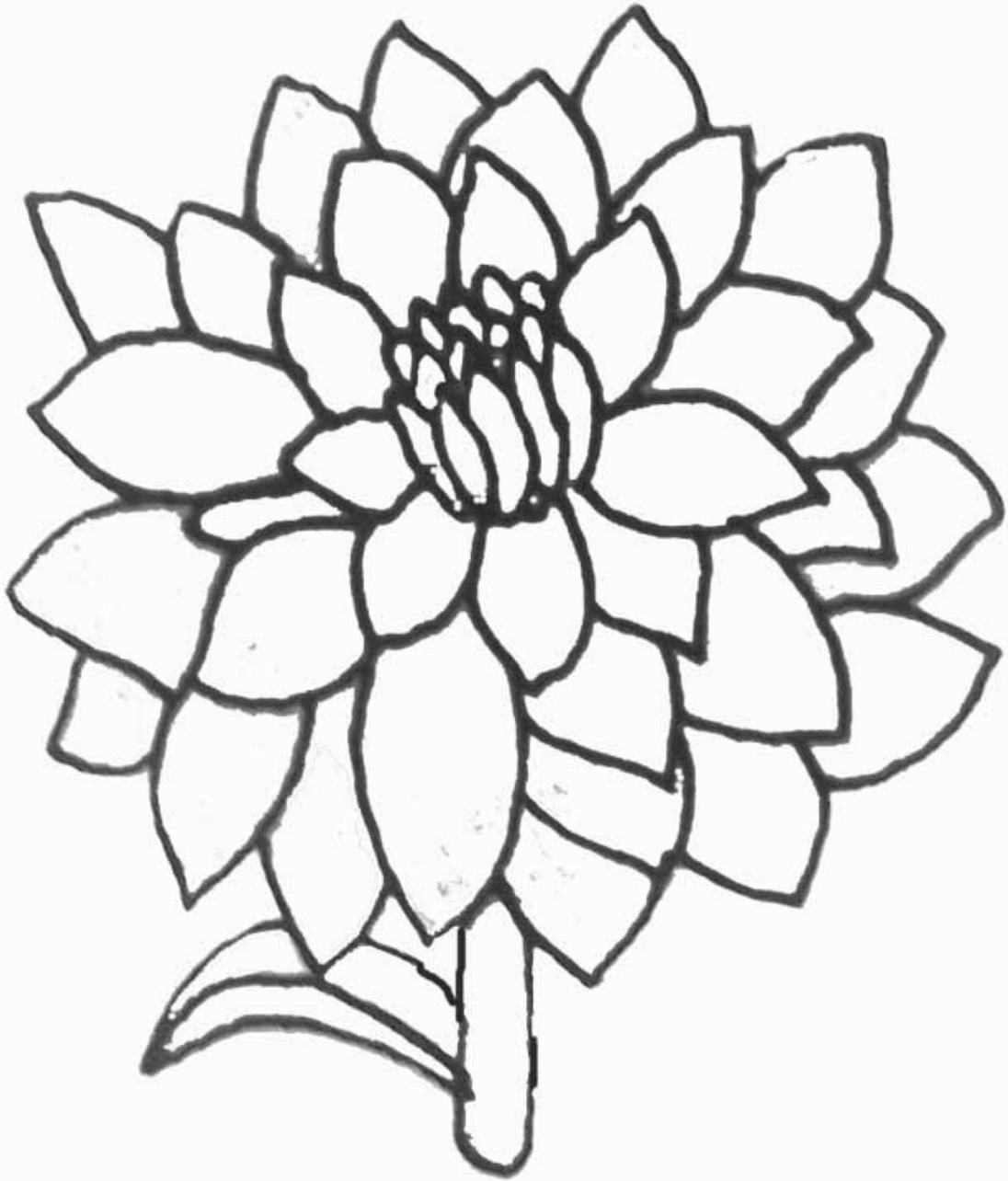

dalio

E

(ε)

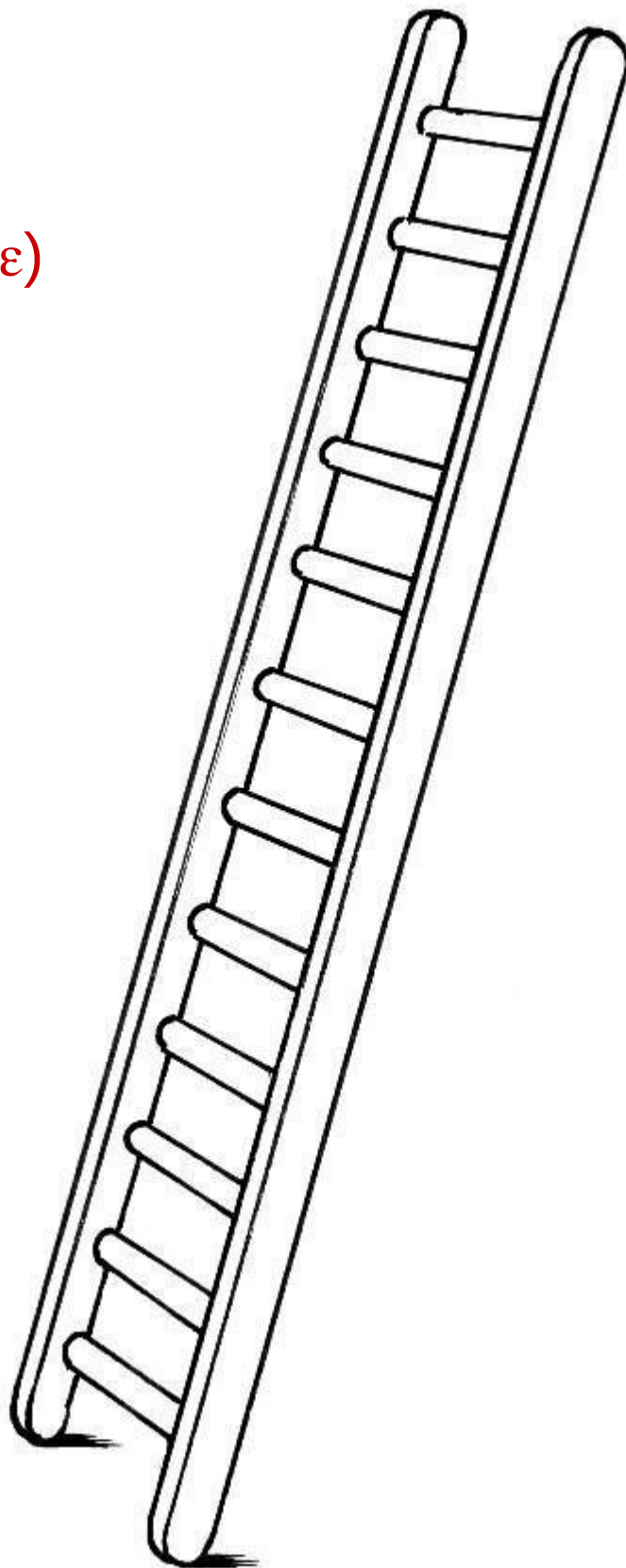

eskalo

**F**

(f)

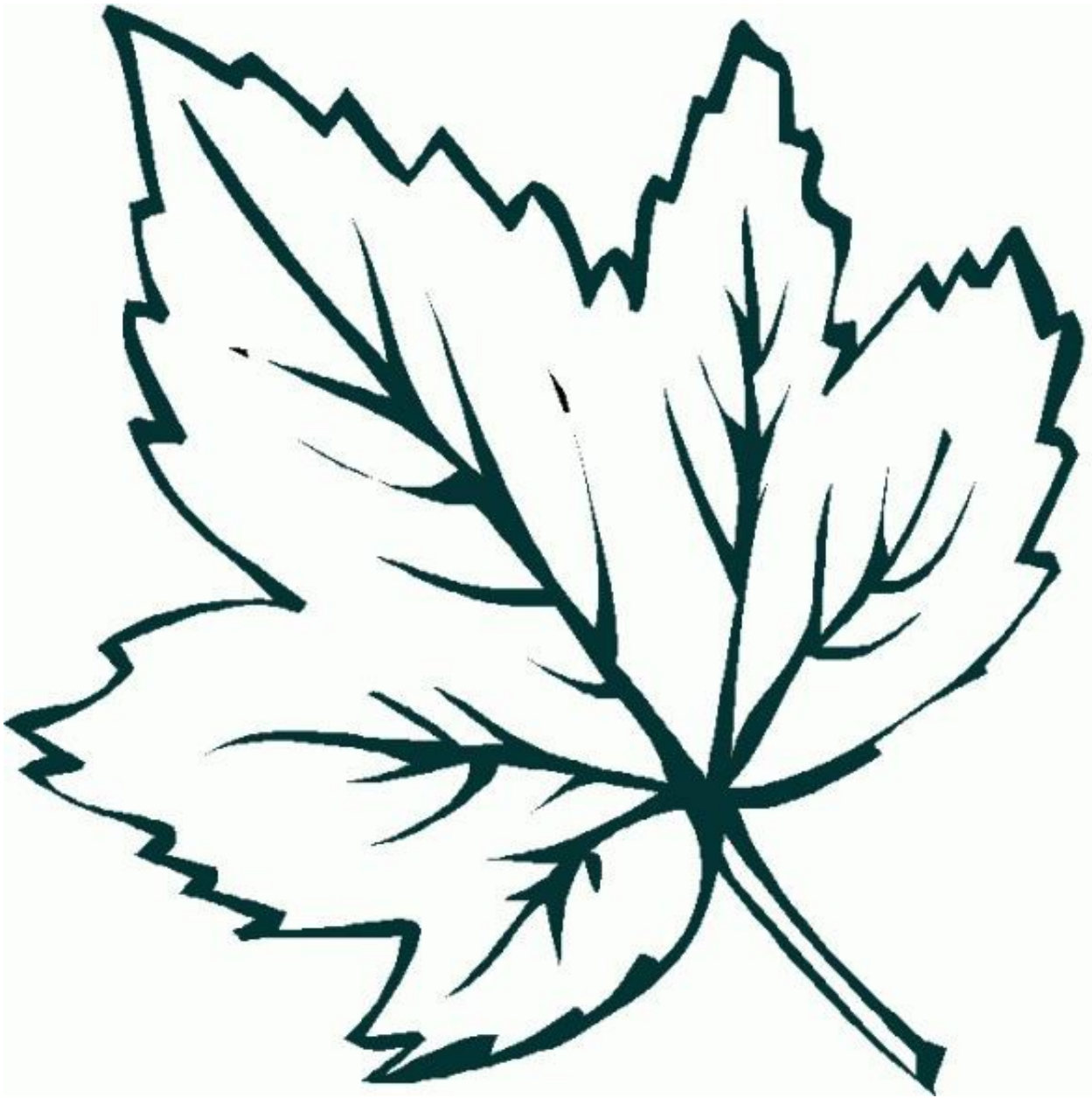

**folio**



**G** (g)



**gnomo**



**Ĝ** (d 3)

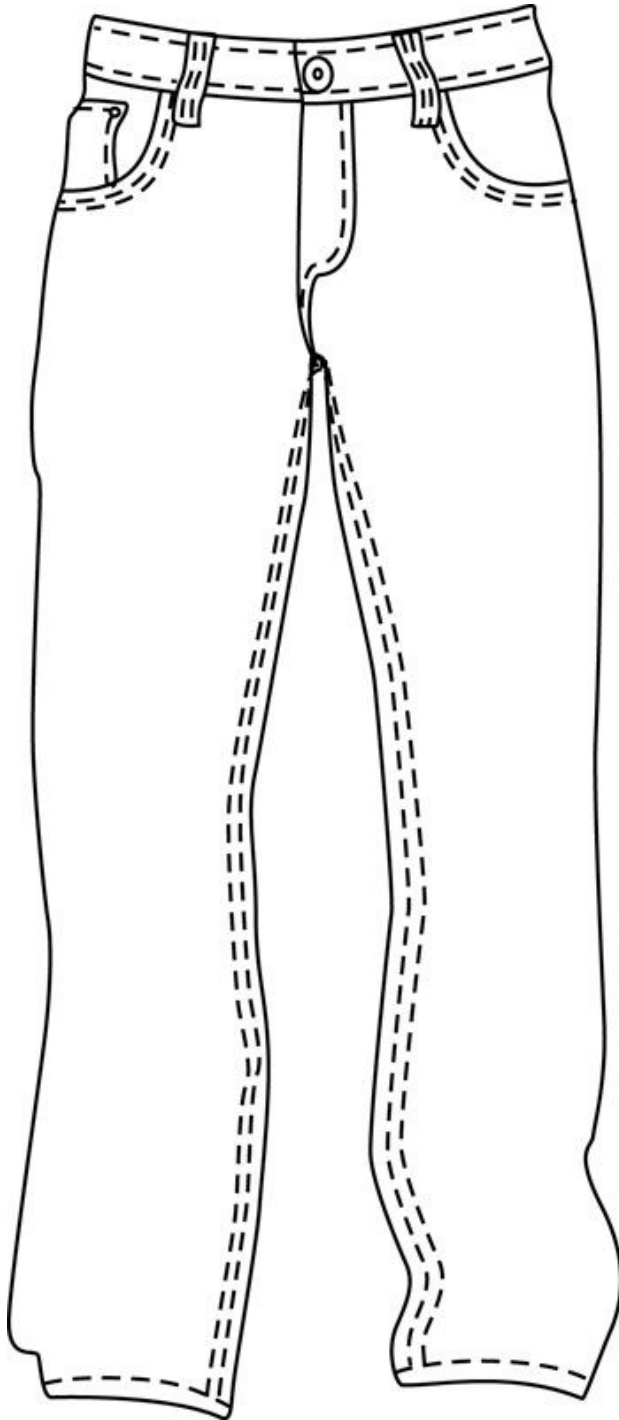

**ĝ**inzo

H (h)

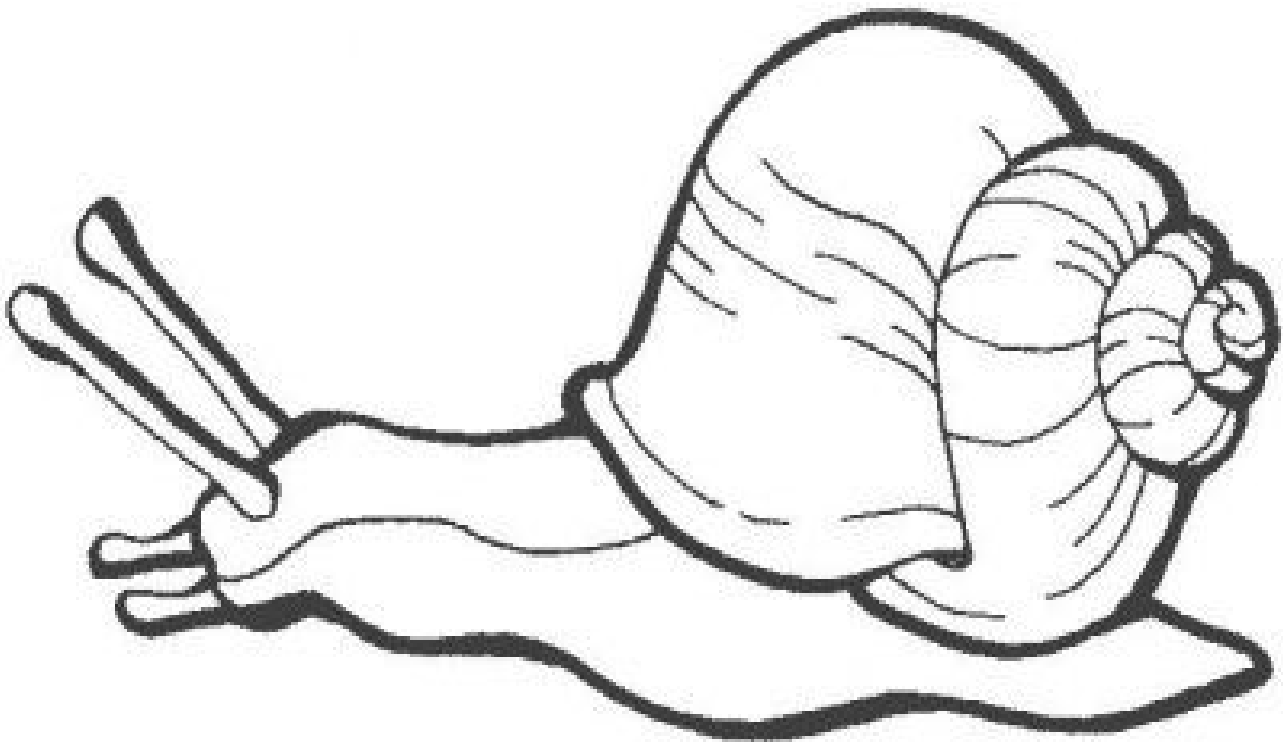

heLiko

À

(x=jotaespagnoles)

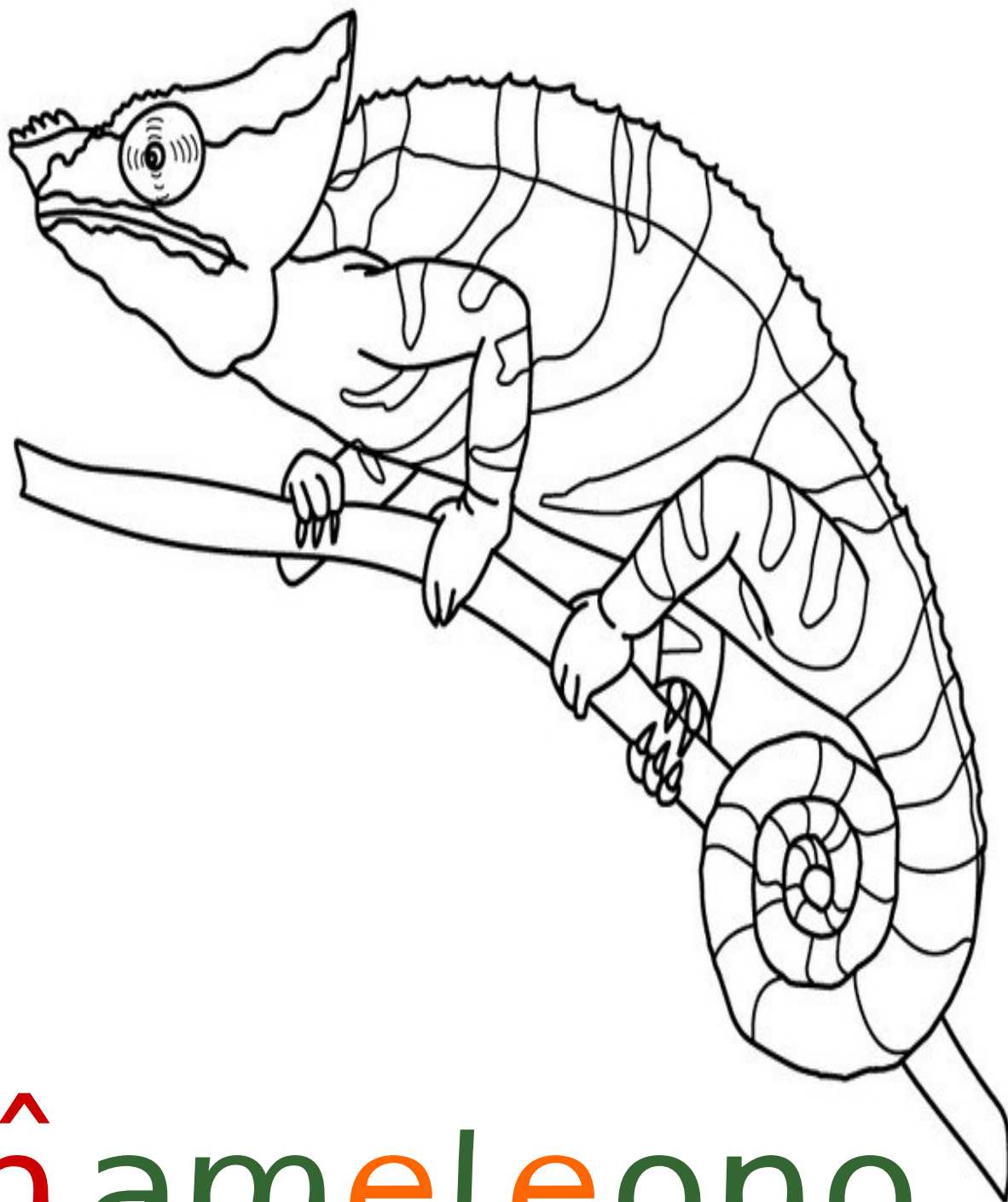

hameleono

I

(i)



ipomeo

J (j)

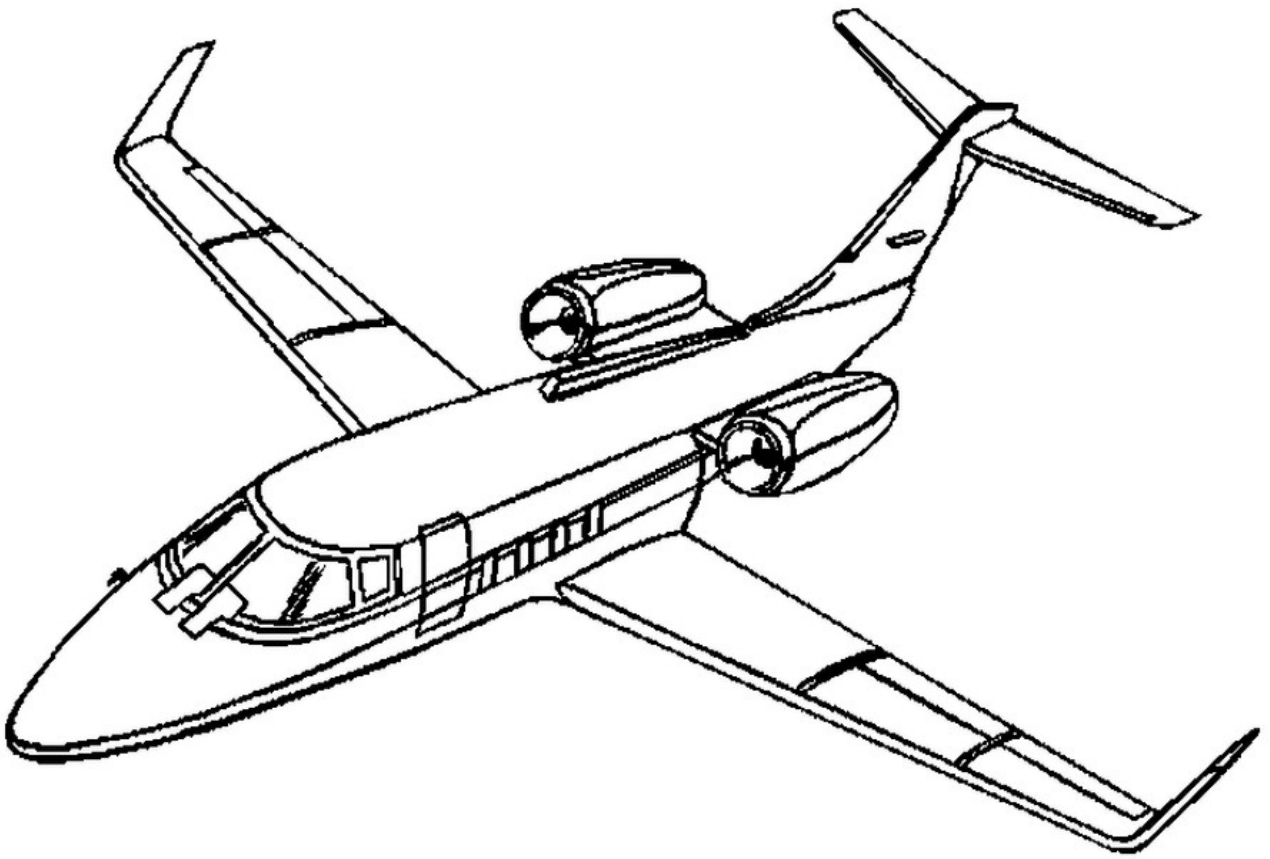

jetto

J

(3)

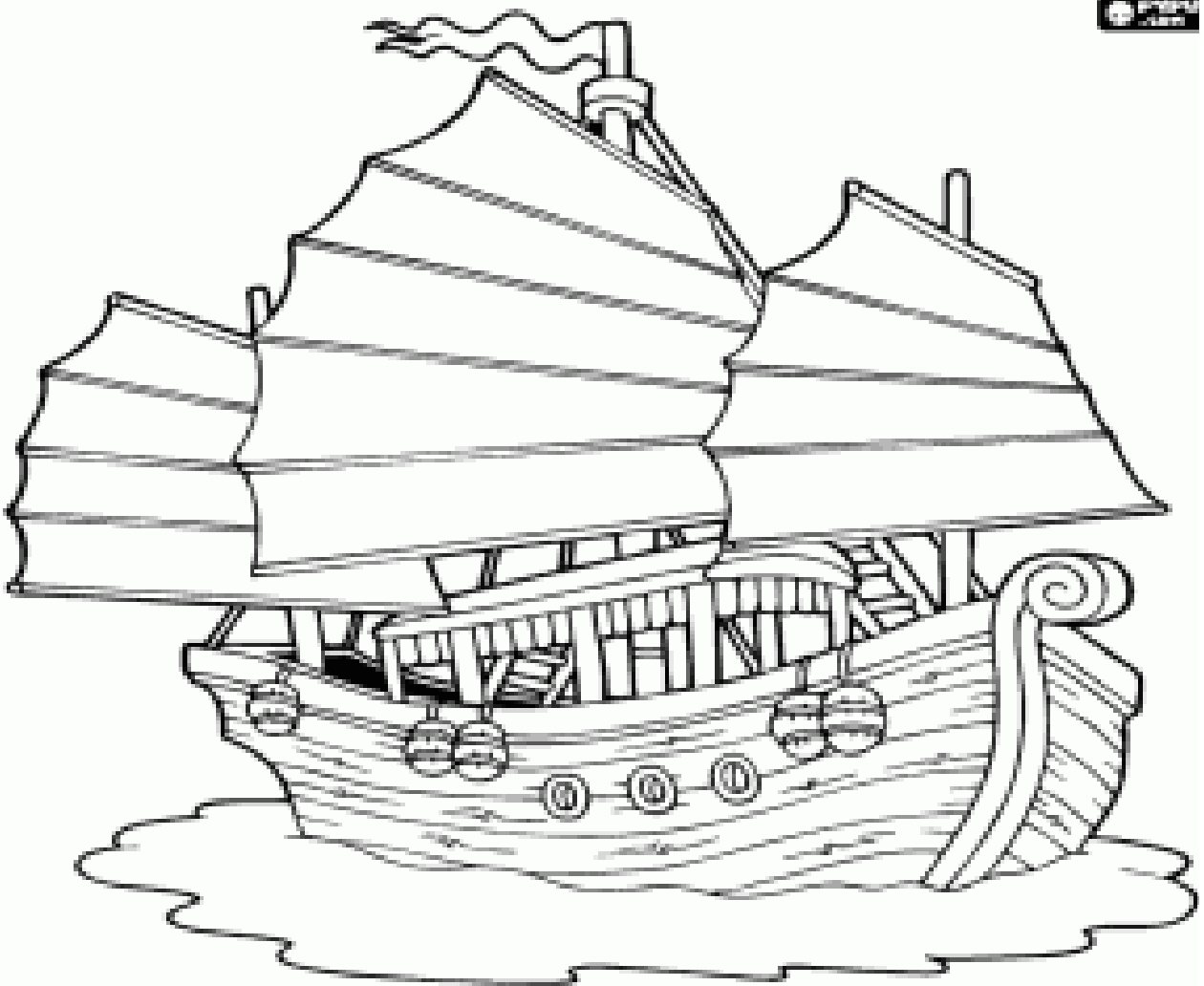

junko

**K** (k)

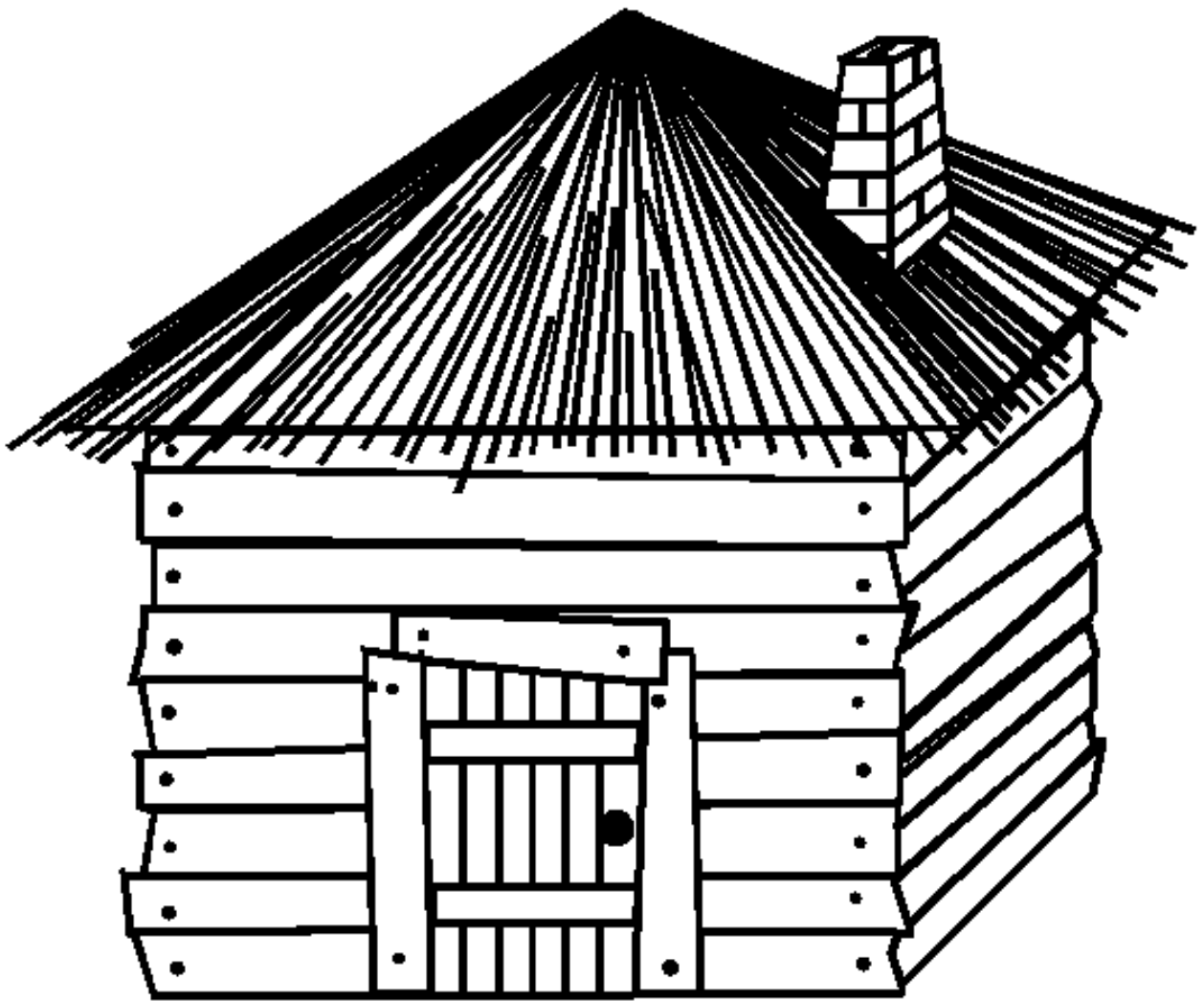

**kabano**



**L** (L)

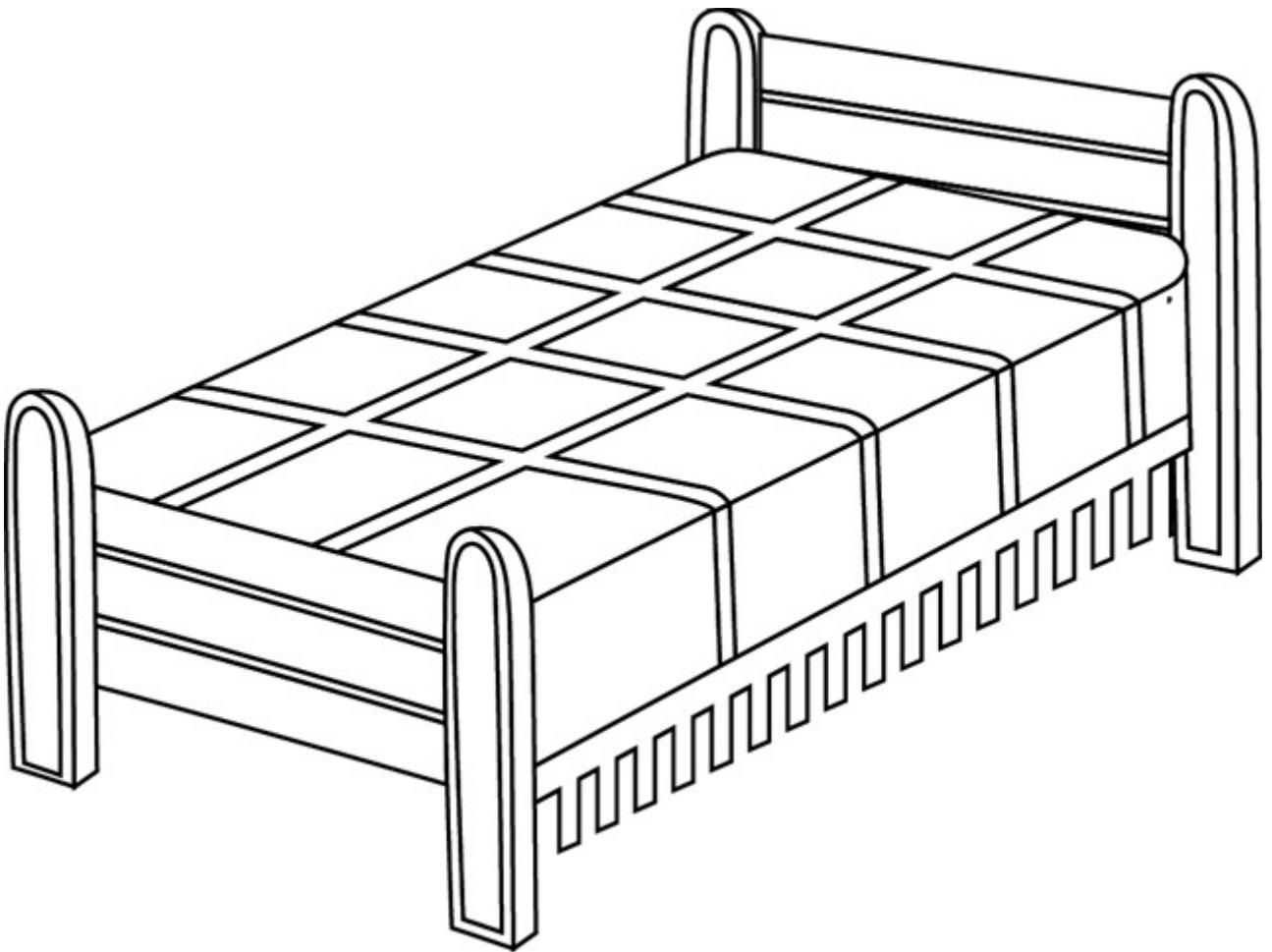

**Lito**

**M** (m)

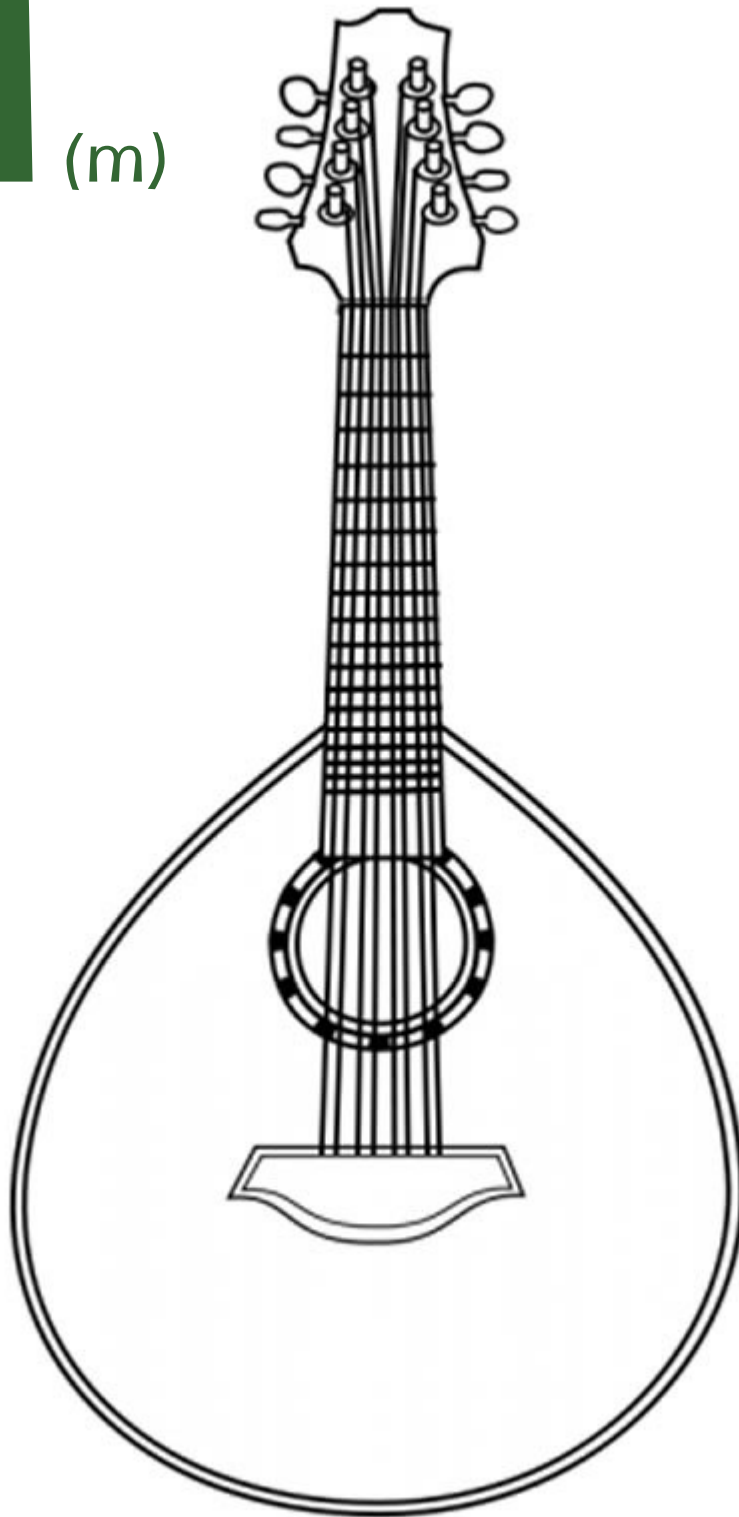

**mandolino**

N (n)



najlo

O

(3)

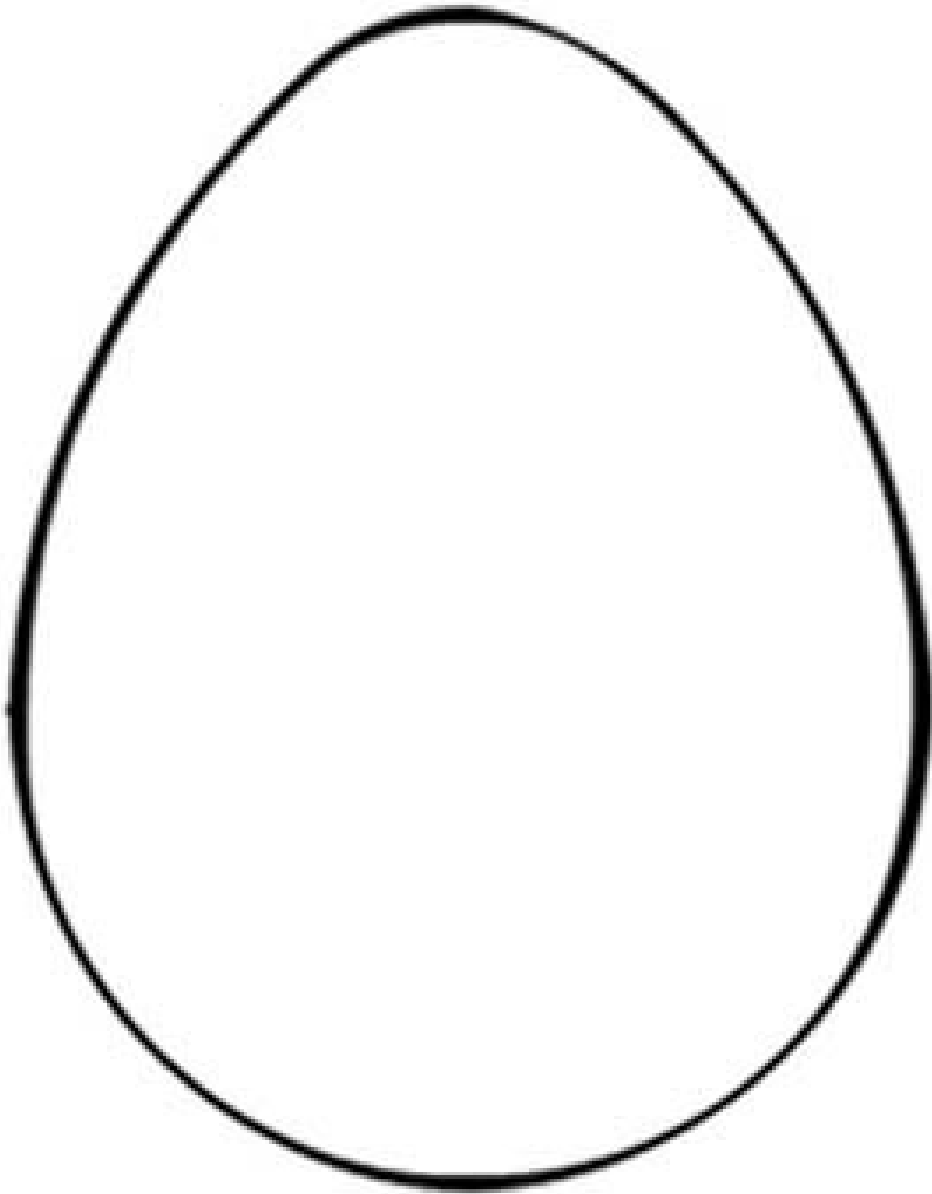

OVO

P

(p)

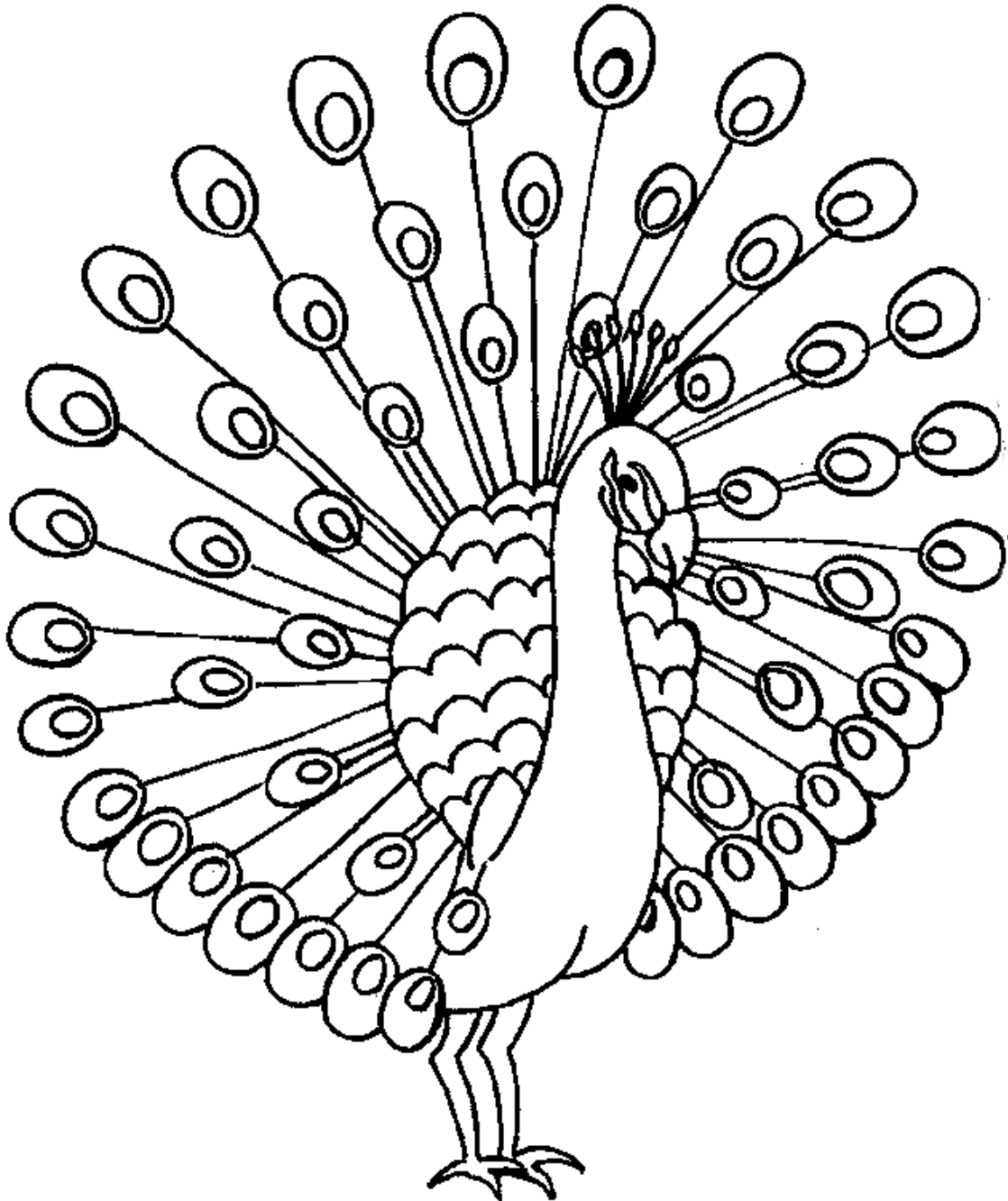

pavo

R (r)

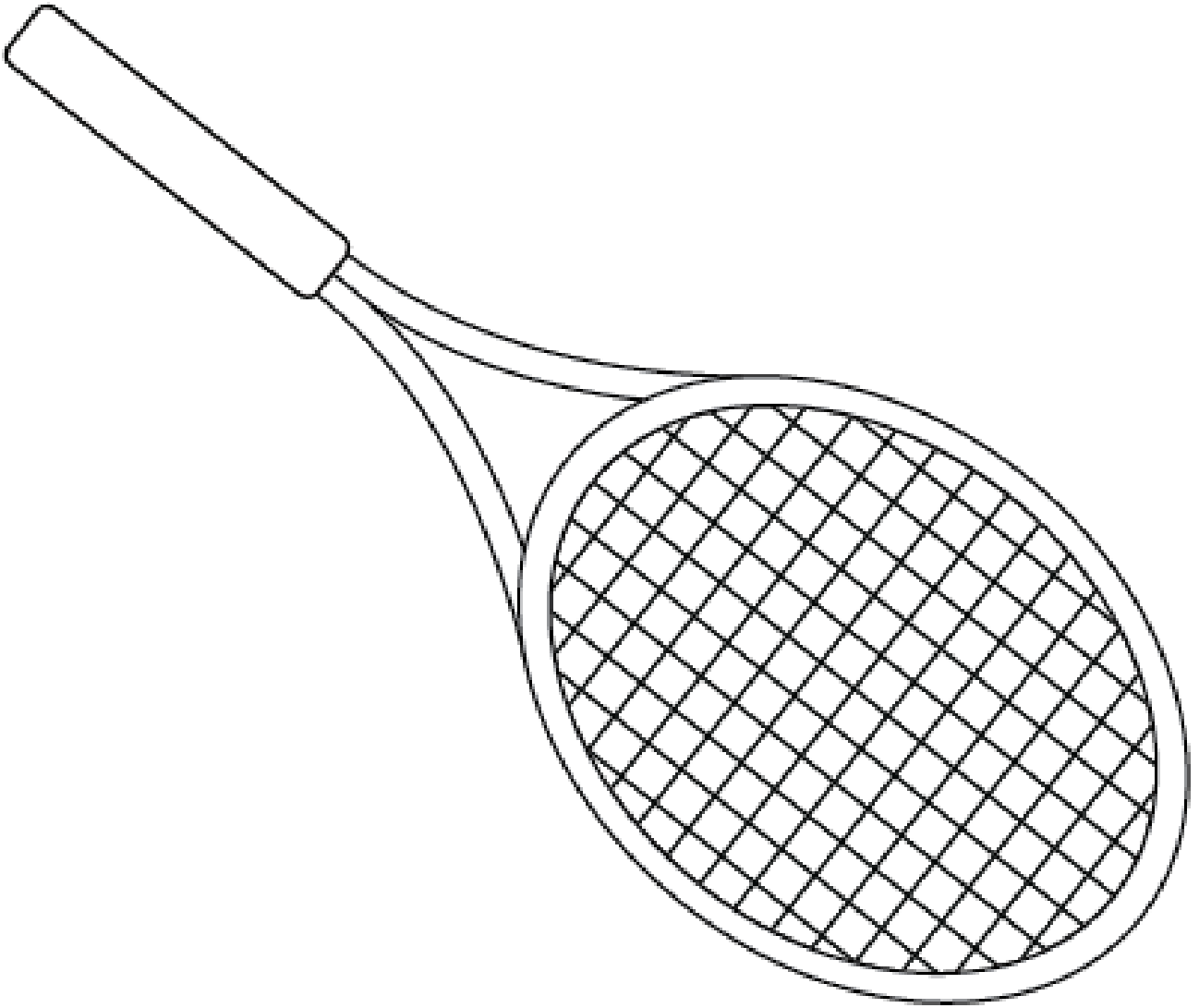

rak edo

S (s)

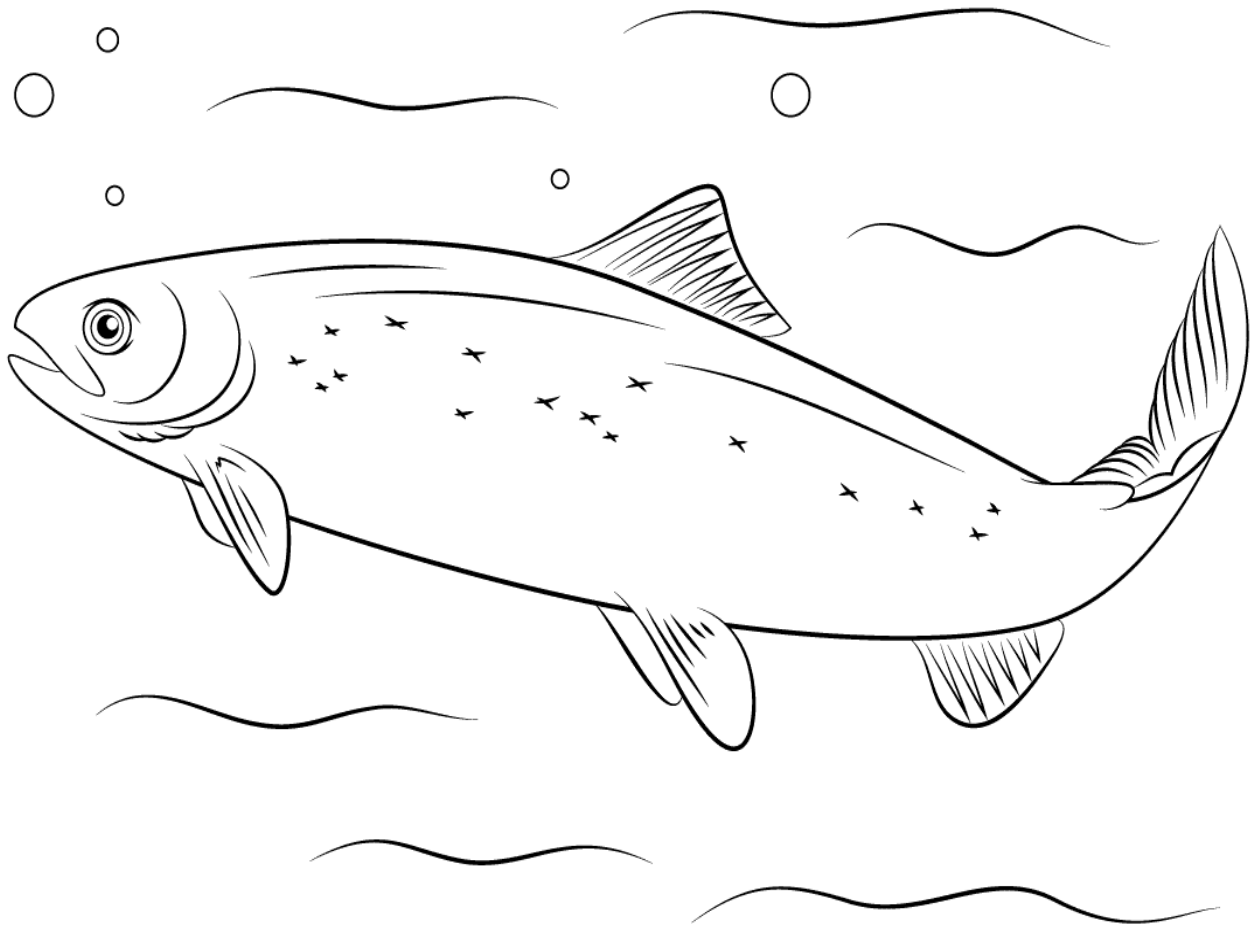

salmo



Ŝ

(ŝ)

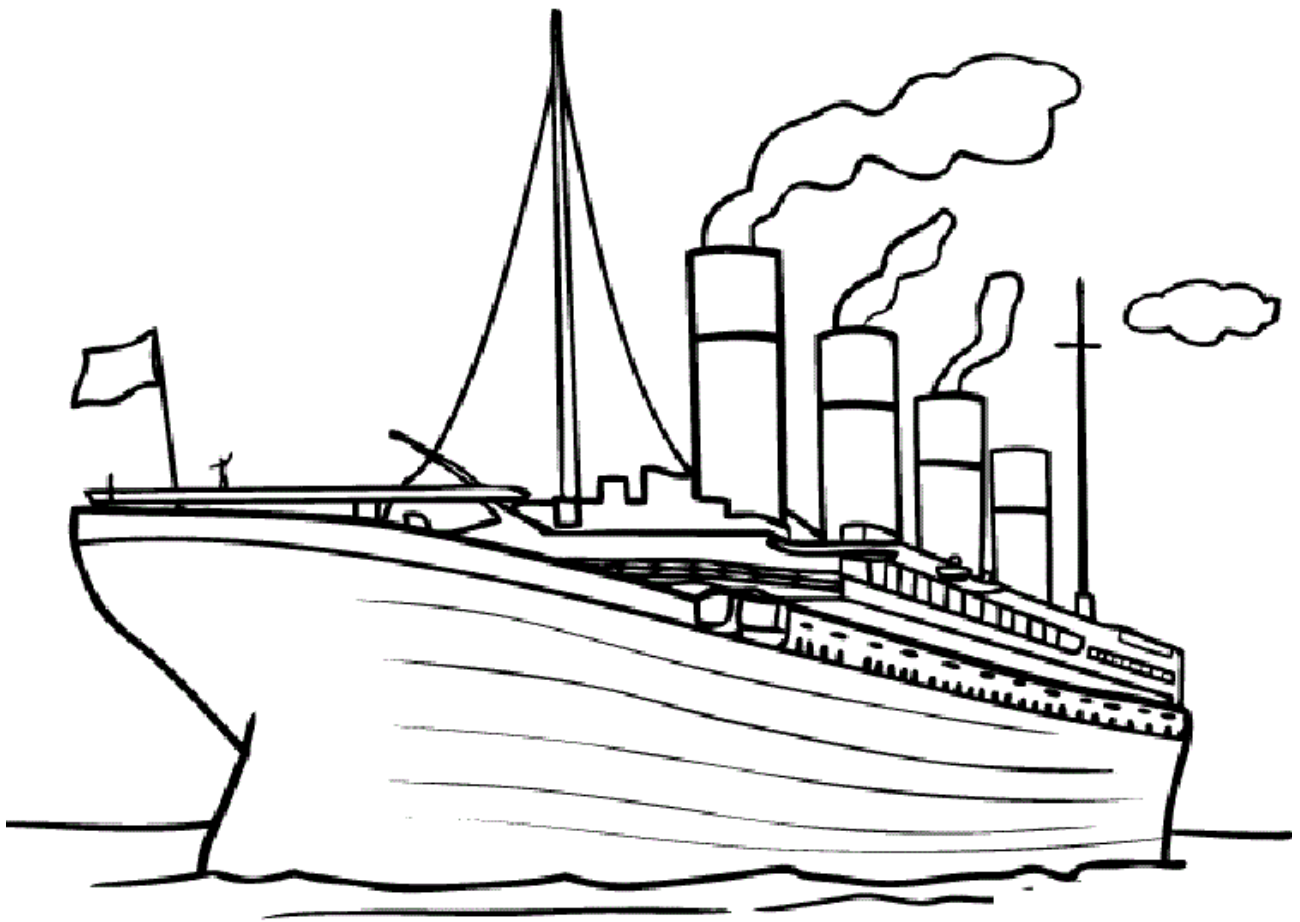

ŝipo

T

(t)

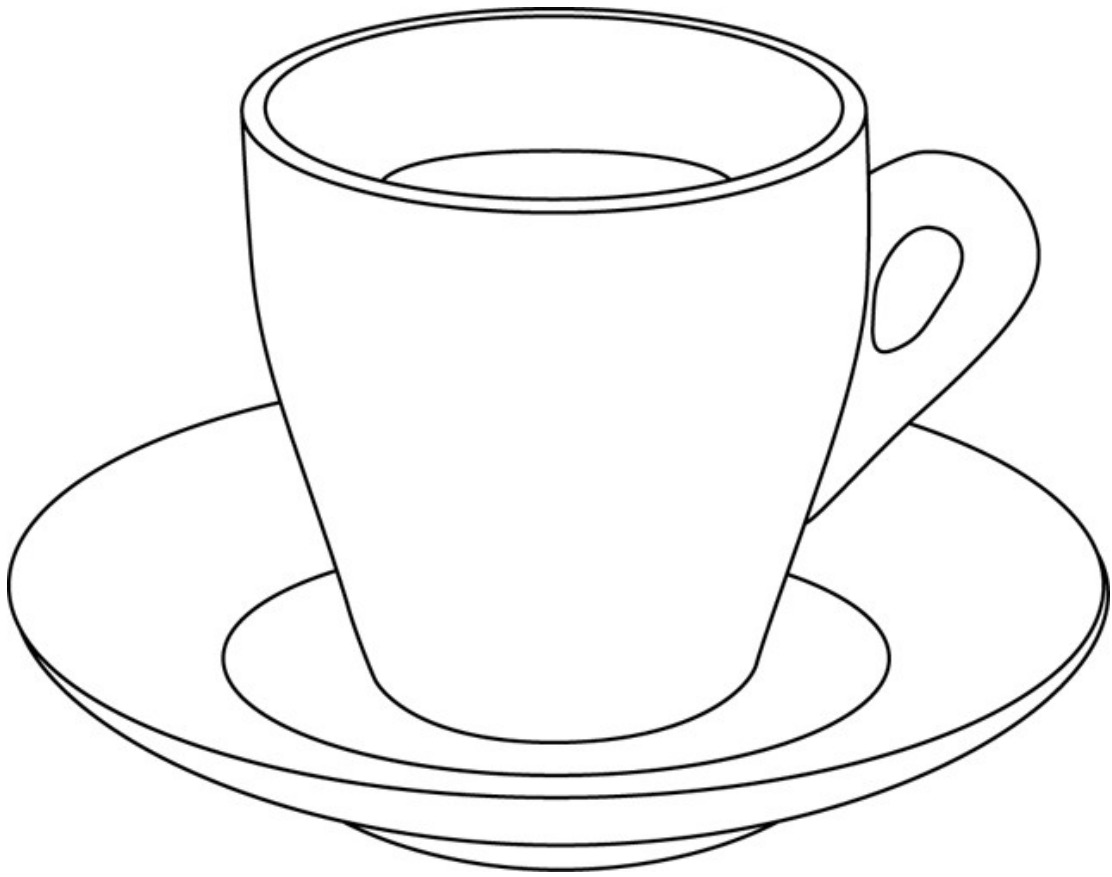

tasó

U (u)



urso

Ů

(w)

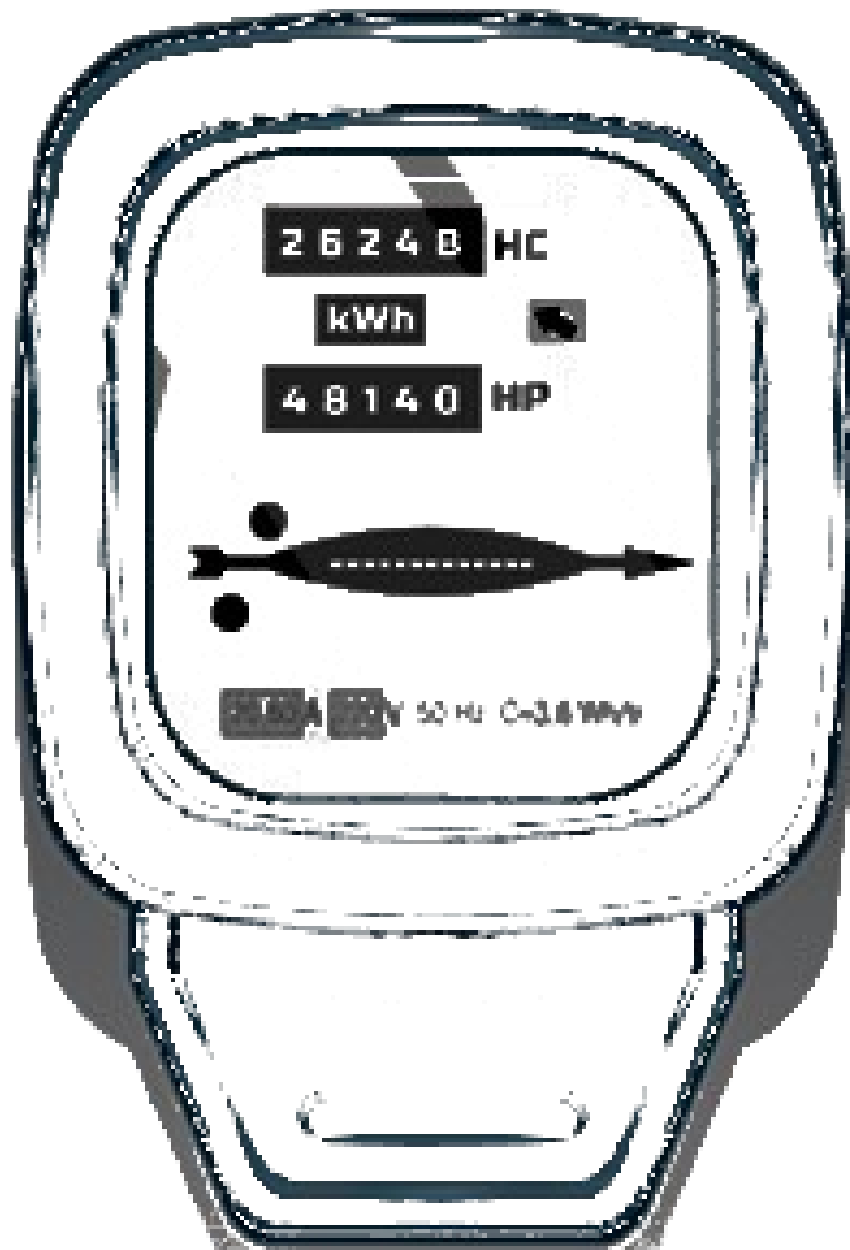

Ůato

V

(v)

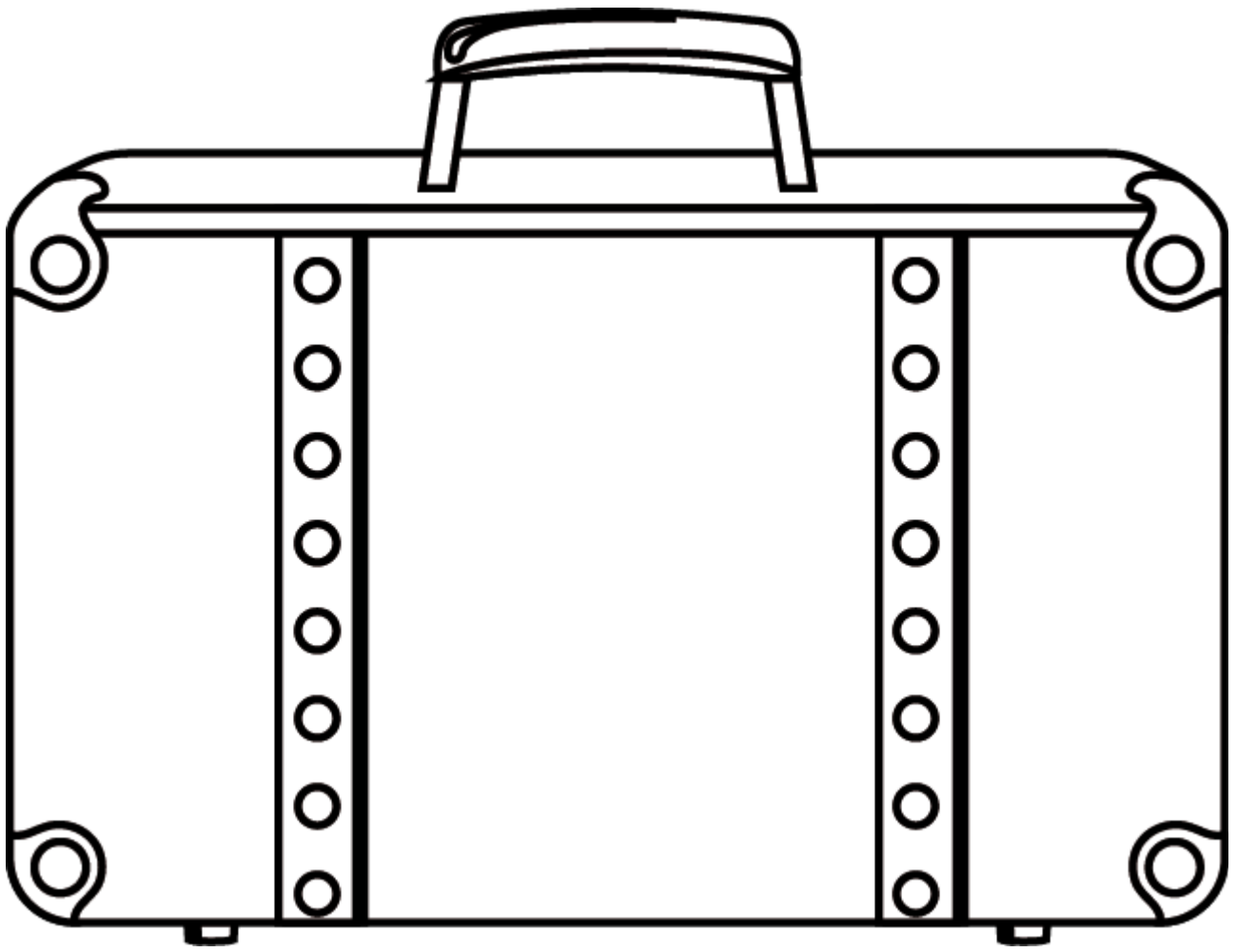

valizo

Z (z)

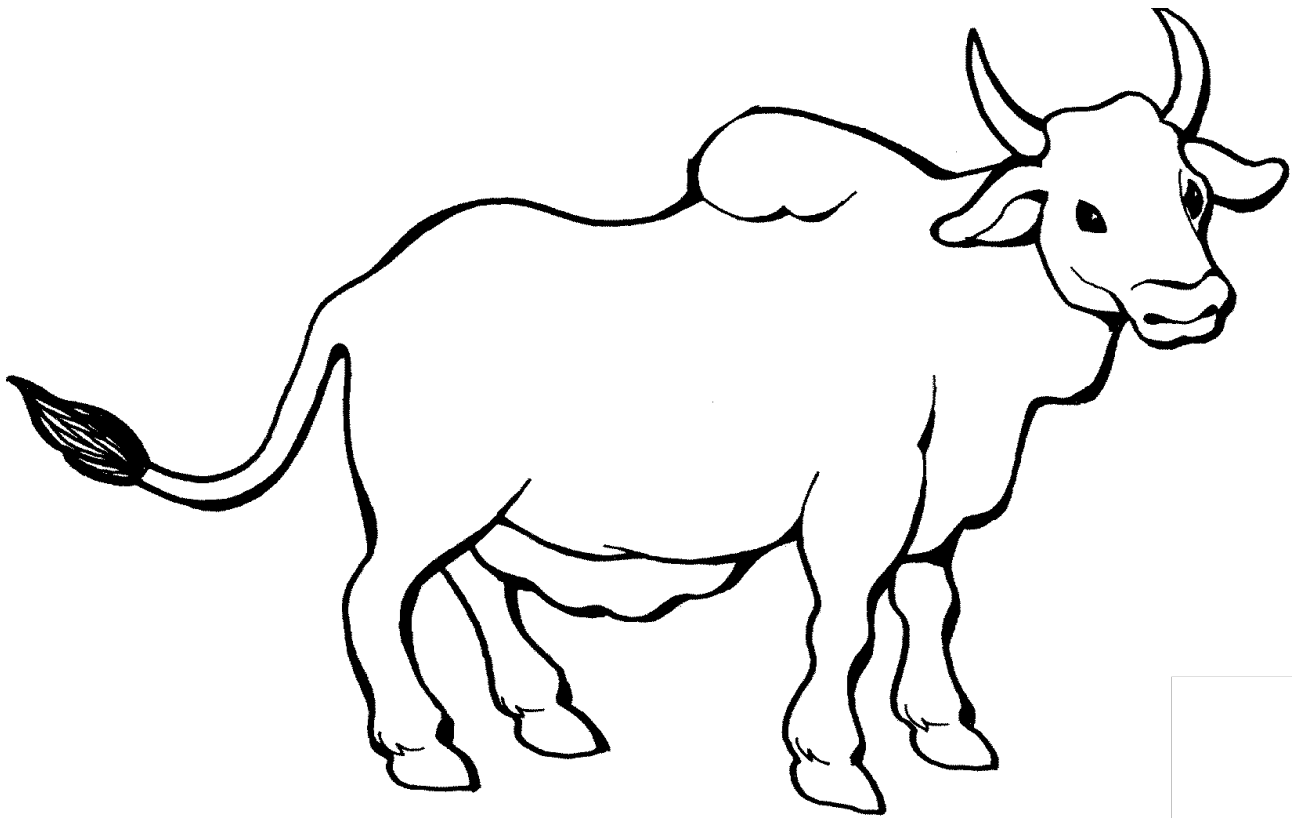

zebuo